



Schindler 3000 Plus

Stylish, functional and flexible



Schindler modernization solutions

Keeping passengers moving

We're using our globally renowned expertise to provide you with the very best elevator modernization solutions. Our Swiss-precision engineering and proven systems improve the reliability, safety, performance and aesthetics of your elevator – increasing your building's overall value.



Benefit from latest technologies

Our replacement elevators allow your passengers not only to enjoy noticeably smoother, quieter operation but also another level of passenger experience thanks to digitally enhanced mobility. Residents and tenants will appreciate the additional comfort and convenience your modernization brings to their life. Enjoy seamless mobility with no complaints.

Minimal downtime and disruption

Our global competencies and expertise make it sure to minimize building adaptations and optimize the installation process when replacing your elevator, setting new standards in the field. In fact, installing our replacement elevators requires up to 40% less time than a conventional replacement. That means that residents can look forward to minimum disturbance and downtime, and you can enjoy a professional and hassle-free process from ordering to handover.



Improved safety and code compliance

Safety is a top priority at Schindler. Our new, modular-platform product range ensures improved safety for customers, visitors, residents and passengers. Our elevator systems meet the latest EU safety requirements and is EC type-certified according to the latest regulations (New Lifts Directive 2014/33/EU, European lifts standards EN 81-20/50, European standard EN 81-21 for new lifts in existing buildings, and optionally European standard EN 81-70 regarding accessibility to lifts for persons with disabilities).



Schindler 3000 Plus

Stylish, functional and flexible

Schindler 3000 Plus is made to be flexible in every way and fits perfectly in your building. Tailored to multiple applications in any urban environment, it will give your building a new lease on life, increasing its value and functionality. Select from a full spectrum of styles, colors and options to find the best possible match for your building.

Schindler 3000 Plus is part of Schindler's new modular-platform replacement product range for residential and commercial buildings worldwide, from low-rise to mid-rise and from basic to sophisticated requirements.

Key figures

Capacity	320–1350 kg
Travel height	Up to 70 m
Stops	Max 24 stops
Speed	1.0–1.75 m/s
Drive system	Machine-room or machine-room-less, eco-friendly regenerative drive technology, frequency controlled
Group size	Up to 6 cars
Entrances	One- or two-sided
Interior	3 interior design lines, fresh wall colors and wide range of fixtures, and bare car option



Designed to fit – built to last

Engineered to Swiss standards for 24/7 operation and for a perfect fit.

Outstanding flexibility

The widest range of applications and maximum flexibility in car dimensions along with door sizes and position.

Future ready

Elevators designed to interface with next-generation technologies.

PORT Technology

Optionally, an integrated building security access solution with increased elevator efficiency and comfort.

Multiple design options

Three full-design lines to complement your building interior, or choose your own design.

Designed to fit – built to last

Engineered to Swiss standards

A combination of pre-engineered components and flexibility right where it's needed ensures the best fit in existing buildings and provides smooth, quiet and economical operation. The latest technologies ensures excellent energy efficiency and minimal environment impact.



The latest technologies, greater comfort

Variable frequency drive systems deliver perfectly controlled power to traction machines and door drives, extending component lifetimes and increasing energy efficiency. Schindler Suspension Traction Media is light and long-lasting, enabling the use of smaller traction machines that reduce both energy consumption, noise and vibration levels in the car.

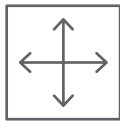

Developed for a perfect fit

Schindler 3000 Plus has been pre-engineered to fit in existing buildings. Flexible car dimensions optimize car size in the existing shaft, while the high variety of door types and millimeter-accurate positioning avoid the need for building work on landings. At the same time, variable shaft pit and head dimensions ensure easy adaptation and quick installation.



Innovative drive technology

Schindler 3000 Plus is equipped as standard with our innovative, regenerative drive technology. The system is designed to reduce travel energy by up to 30% compared to conventional technology.



Excellent ecological performance

Improving energy efficiency is essential for reducing the environmental impact of elevators and the buildings they serve. Eco-friendly features such as regenerative drive, LED lighting and stand-by mode while parked are standard in all Schindler 3000 Plus elevators. This makes it possible to achieve the highest energy-efficiency rating, class A according to ISO 25745-2.*

*The classification always refers to a specific customer configuration. Usage pattern, load capacity, customer-specific options and site conditions influence the final rating.



Outstanding flexibility

The best use of space

Schindler 3000 Plus has outstanding architectural flexibility for car, door and shaft dimensions. Less space taken up by components means more room and comfort for your passengers.

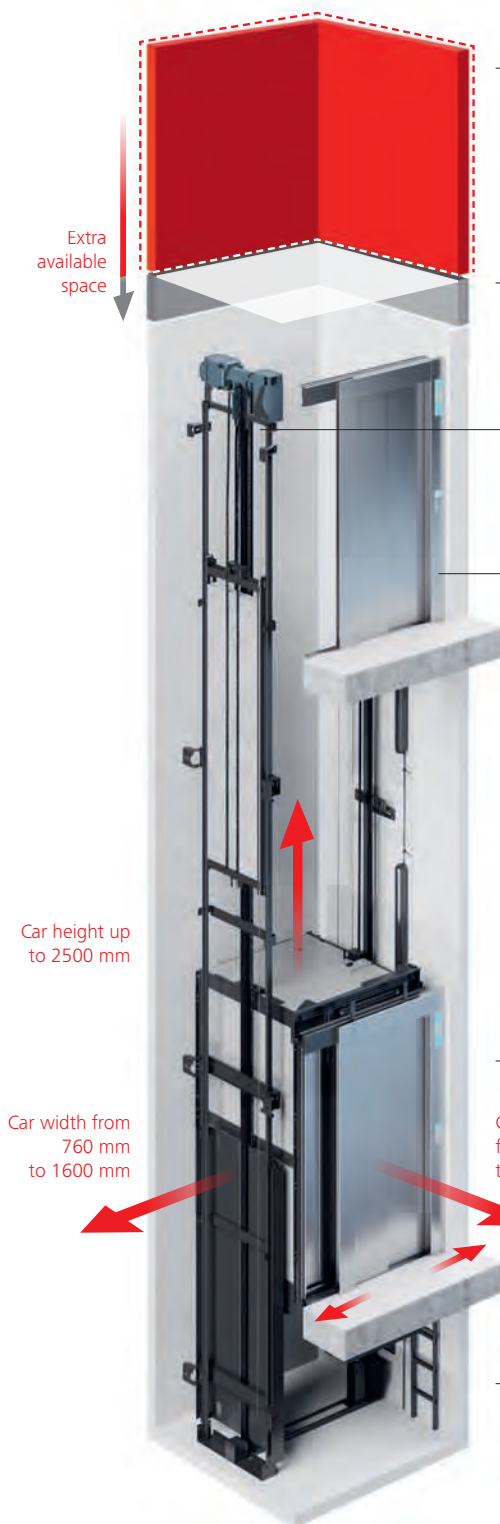

Machine-room-less design

All the main drive, traction and control equipment sits in the shaft, leaving the machine room space free for other uses, and making it easy to extend lift access to the top floor thanks to the reduced headroom requirement.

Reduced headroom

The system is designed to require minimal headroom in order to fit in the existing shaft headroom.

Smaller motor and traction sheave

Suspension Traction Media (STM) saves shaft space and energy by using a smaller motor and sheave.

Built-in controller on landing door

The Schindler 3000 Plus controller panel is integrated into the landing door frame, for simple installation and maintenance access. Optionally, the controller can be installed on other floors as well as in another place near the shaft or in the former machine room.



Modular system, scalable car and door dimensions

We can adjust car width and depth for you in 10 mm increments. Schindler 3000 Plus car width can range from 760 mm to 1600 mm, car depth from 900 mm to 2400 mm, and car height right up to 2400 mm, in 100 mm steps. Doors can be positioned with millimeter accuracy.

Reduced pit depth

Minimal pit depth requirement to fit in the existing shaft pit

Flexible Door Dimensions

Adaptable to any space

Avoiding changes to the landing walls and floor is very important when replacing an elevator. Schindler 3000 Plus offers a large variety of door types and layouts to fit the existing space perfectly, eliminating the need for modifications and resulting in easy installation.



Door types and dimensions

The door width is adjustable in 50mm increments from 600 mm to 1400 mm, and the height from 2000 mm to 2400 mm in 100 mm increments with a choice of telescopic (T2) or center-opening doors (C2, C4) for single or double entrance (through-loading). For specific cases a flat symmetric or asymmetric C4 panel door is also available.



Metal front

Metal extension fronts combined with the landing doors are also available to partially or fully cover the landing shaft front.

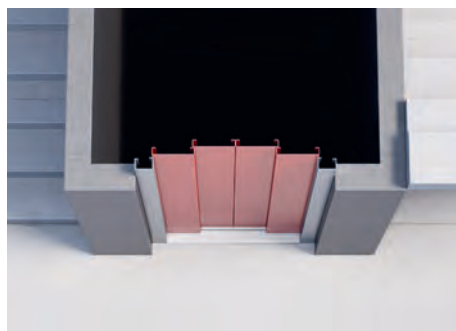

Frameless landing doors

As an alternative to standard box-framed landing doors, frameless doors (which reuse existing landing frames) are also available to preserve the existing finishing of your landing.

Future ready

Designed for next-generation technologies

Benefit from our tools, solutions and latest innovations providing improved equipment reliability, uptime, safety and an all-new superior passenger experience. Our elevators are designed to use state-of-the-art technologies from planning to operation.



Innovation in installation

Schindler's new **INEX (Installation Excellence)** method not only reduces construction preparation and resources for our customers, but also improves safety and efficiency on site.



Digital solutions tailored to your needs

All our new elevators are fully enabled for Schindler Ahead – our digital portfolio for smart elevators. Designed on the principles of IoT (Internet of Things) and machine learning, it analyzes cloud-based data to deliver improved uptime, insights and convenience.



Smart operation – clarity and convenience

Digital connectivity allows for better maintenance and management, while creating higher levels of comfort for passengers. With Schindler Ahead, we make sure that our customers can enjoy the benefits of the digital era with confidence.

– Maximize uptime with Ahead Remote Monitoring

With digital connectivity, issues can be detected and addressed long before service is affected. This helps facilities take timely action to minimize or even avoid downtime. Schindler Ahead maximizes uptime thanks to instant, accurate insights.

– Real-time insights with Ahead ActionBoard

Ahead ActionBoard provides operational, performance and commercial information in real time, giving customers clear, instant oversight of their entire elevator and escalator portfolio.



User experience on a next level

Inform, engage, entertain. Display engaging multimedia content for your passengers and generate new revenue streams through advertising. Turn your elevator into an infotainment hub with **Ahead SmartMirror** and **DoorShow**, or transform user-elevator interaction into a unique, visual experience with the **Linea 800 SmartTouch** interactive fixtures.

With valuable information at your finger tips, preventive and predictive action can be taken more quickly



Real-time insights with Ahead ActionBoard



SmartMirror: new in-elevator multimedia experience changes the way passengers enjoy their travel



Schindler Ahead DoorShow is our new advertisement and information solution for your elevator doors

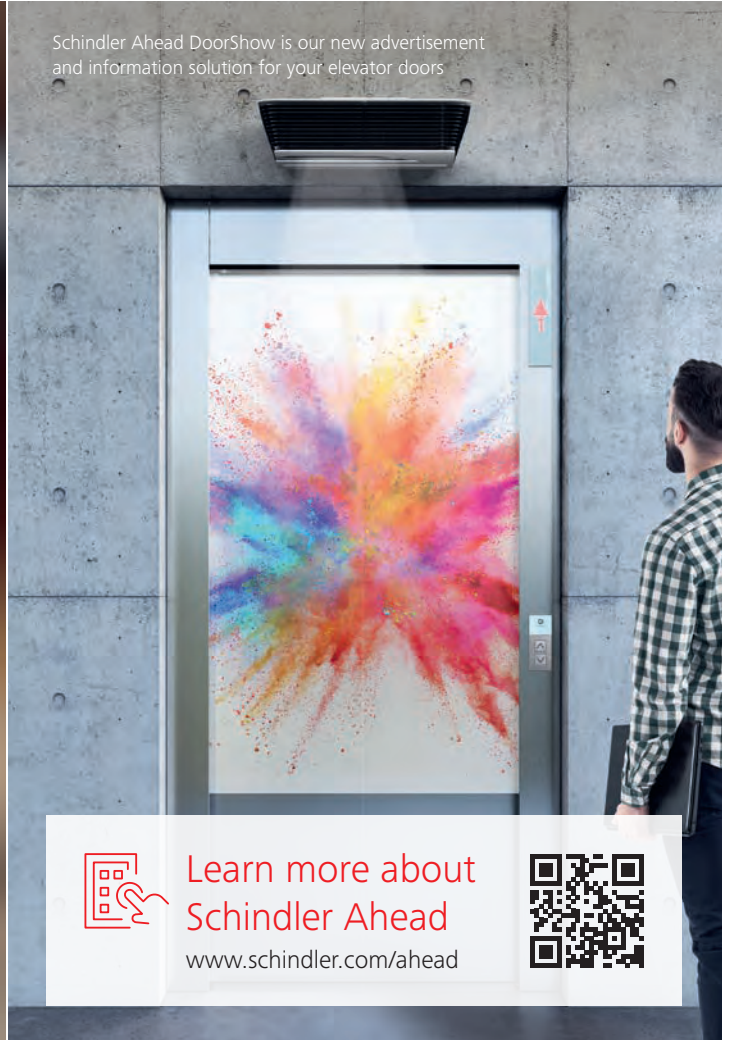

Learn more about
Schindler Ahead
www.schindler.com/ahead



Navona
Functional and durable



Times Square
Modern and versatile



Multiple design options

Ready-made interior design lines

Navona

Functional and durable

Clarity and comfort in your car with this robust design line. Fresh colors, durable accessories, and the option of five different floors make Navona an excellent choice for residential applications. Stainless steel options are also available for the rear and side walls.

Park Avenue

Sophisticated and elegant

A touch of class. Wooden and textured laminates or back-painted glass walls for a rich, contemporary mode. Or a luxury feel with stainless steel in seven different finishes or decorative glass. Matched lighting completes Park Avenue's elegance.

Times Square

Modern and versatile

A contemporary look. Choose from warm or cool colors or combine to enhance contrast for more depth. Times Square adds distinctive features to any public, commercial or residential building.

Note: Specifications, options and colors are subject to change. All cars and options illustrated in this brochure are representative only. The samples shown may vary from the original in color and material.



Freedom of design

Create the look and feel you like

Choose an elevator design that perfectly matches your building interior. Select from Schindler 3000's three décor lines and combine your choice with our range of operating panels, handrails, lighting, mirrors and other accessories.

And for full custom designs, the Schindler 3000 bare car option allows you to add up to 30% of the car's rated load capacity for the materials and finishings of your choice.

Car operating panels and landing fixtures

Outfit your elevator with style

Linea 100

Linea 100 offers functional design in stainless steel. The integrated white glass display comes with large, easily readable red LED dot matrix floor indicator. Push buttons have clear red illumination when a call is recognized.

Linea 100 Touch

The convenience of our typical user interface converted to a touch version. The stylish design is in resistant glass with light indication to signal all functions, and dot matrix displays with large, easily readable red LEDs.

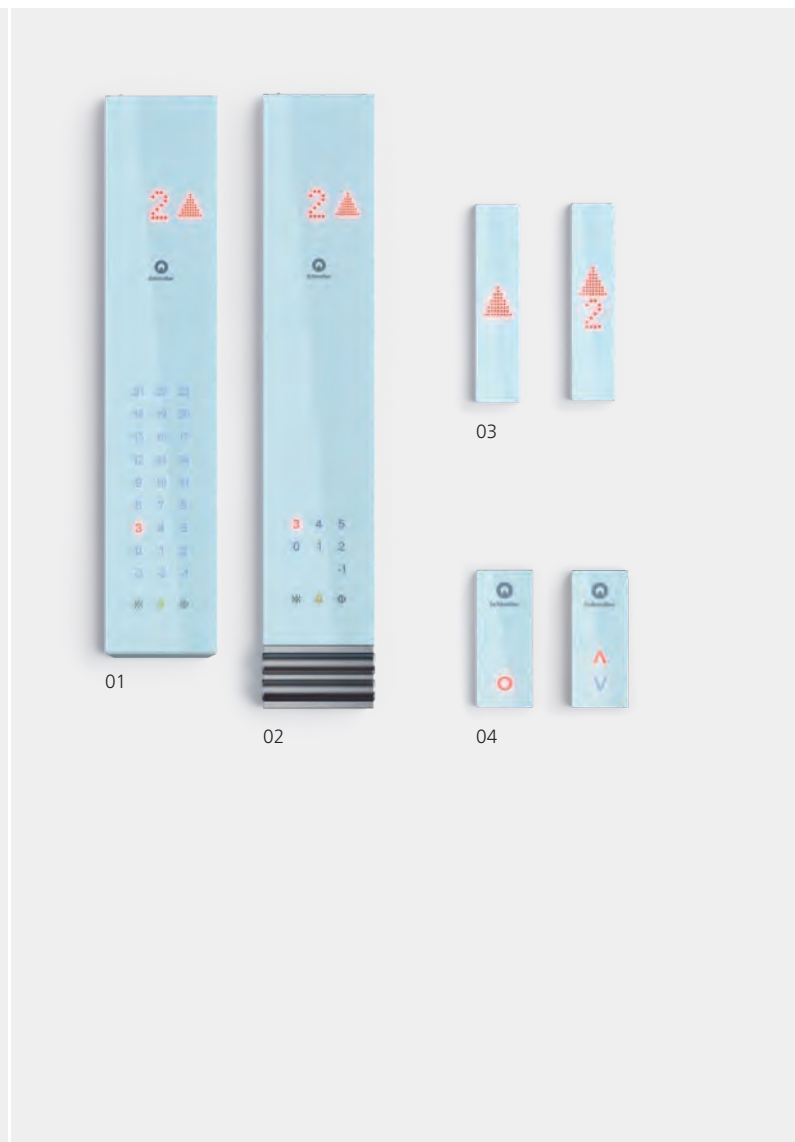
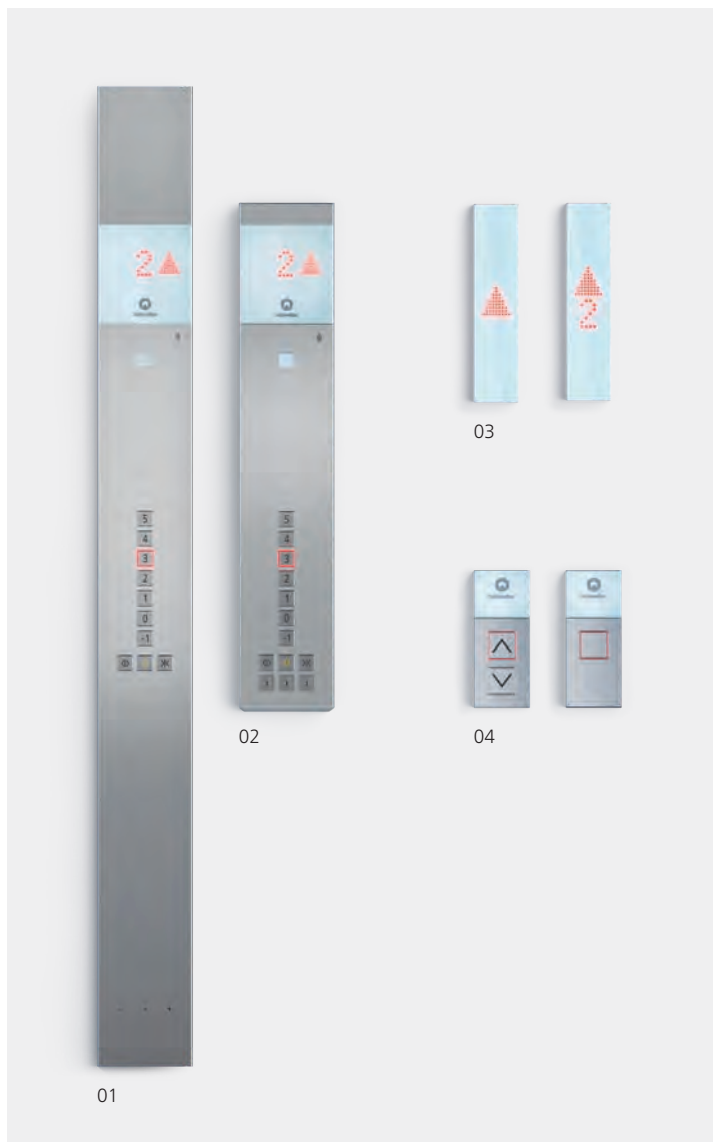

- 01 Full height car operating panel
- 02 Half height car operating panel
- 03 Car position & direction indicators
- 04 Landing operating panels

- 01 Car operating panel
- 02 Car operating panel with key switch
- 03 Car position & direction indicators
- 04 Landing operating panels

Linea 300

An upmarket user interface to enhance your elevator's looks, with an intuitive, efficient design. The display is in black glass, with buttons positioned on elegant black stainless steel, or white glass display on typical stainless steel color finishing.

Barrier-free mobility

We offer a wide-ranging portfolio of special fixtures for passengers with reduced mobility. This includes easily identifiable large push-buttons with raised symbols (EN:81-70 norm) and Braille to help visually impaired and aged people in their orientation.



- 01 Full height car operating panel
- 02 Car position & direction indicators
- 03 Landing operating panels



- 01 Full height car operating panel (EN:81-70)
- 02 Half height car operating panel (EN:81-70)
- 03 Landing operating panels (EN:81-70)
- 04 Horizontal car operating panel (EN:81-70)

Mirrors

Ensuring optimal appearance

Mirrors enhance the sense of space, depth and comfort in elevators. Schindler 3000 elevators can be fitted with a full-height or half-height safety-glass mirror on the side or rear wall of the car.

Side wall



Half height centered



Full height centered

Rear wall



Half height centered



Half height full width



Full height middle panel

Park Avenue

Laminate Wood Portland Ash walls
Full height middle panel mirror



Landing doors

For a stylish entrance

How your elevator design immerses with your building can enhance your tenants' response to the overall décor design. We offer a full range of colors to help you unleash your building's full design potential.

Landing arrangements

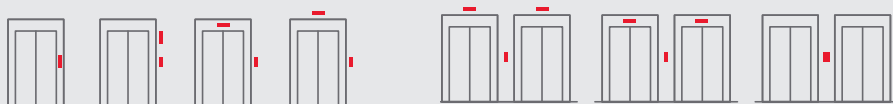

Choose your optimal landing arrangements for simple and multiplex installations, surface or wall mounting.

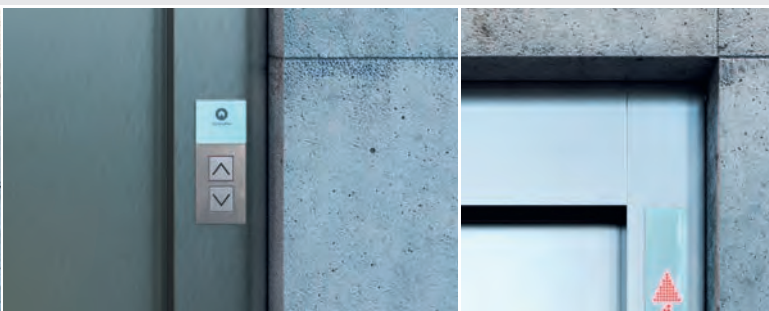

Landing door color options

- 01 Painted Pebble Grey
- 02 Painted Polar White
- 03 Painted Riga Grey
- 04 Painted Ruby Red
- 05 Painted Anthracite Grey
- 06 Stainless Steel Lucerne Brushed (441 + 304)
- 07 Stainless Steel Lasanne Linen (441 + 304)
- 08 Stainless Steel Polished Mirror (304)

Glass door frame options

- 06 Stainless Steel Lucerne Brushed (441)
- 07 Stainless Steel Lausanne Linen (304)
- 08 Stainless Steel Polished Mirror (304)

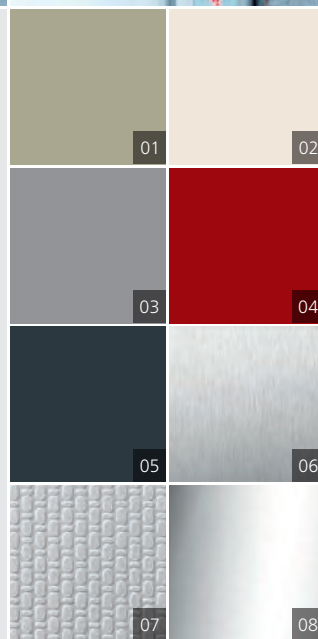

Handrails

A wide choice of shapes and finishes

Handrails convey a feeling of security. Schindler stainless steel handrails are designed to blend with car interiors, shapes and textures, and can be mounted to the side and rear walls. Available in curved, straight, straight with curved ends, and revolving layouts.



Customize your handrails

Handrails convey a feeling of security. Our handrails are designed to blend with car interiors, shapes and textures.

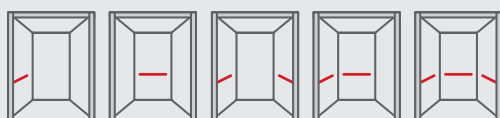

The handrails can be mounted in different combinations of side and rear walls, either only one handrail piece on the rear or side walls, two handrail pieces on the side walls or handrails on three walls. They can be connected straight or revolving.

Choose the handrail shape you prefer:

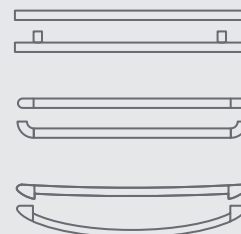

Straight, straight with rounded ends or curved

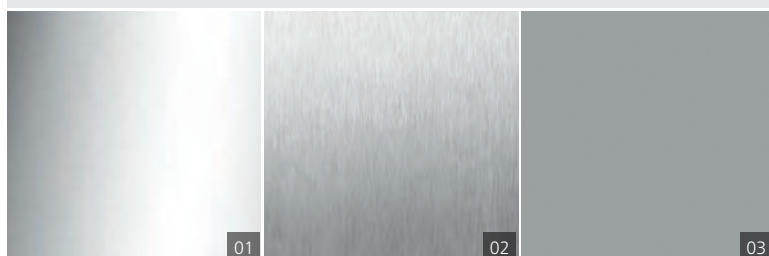

- 01 Stainless Steel Polished Mirror
- 02 Stainless Steel Lucerne Brushed
- 03 Painted Riga Grey

Bumper rails

Preserving your car interior

Designed to protect your elevator car walls and prolong their sleek looks, Schindler's damage bumper rails are available in a variety of heights, and in stainless steel, PVC or wood.

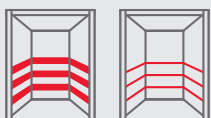

Choose from different heights depending on your requirements. Available in stainless steel, PVC or wood.

01 PVC Coated Black

02 Stainless Steel Lucerne Brushed

03 Solid Wood

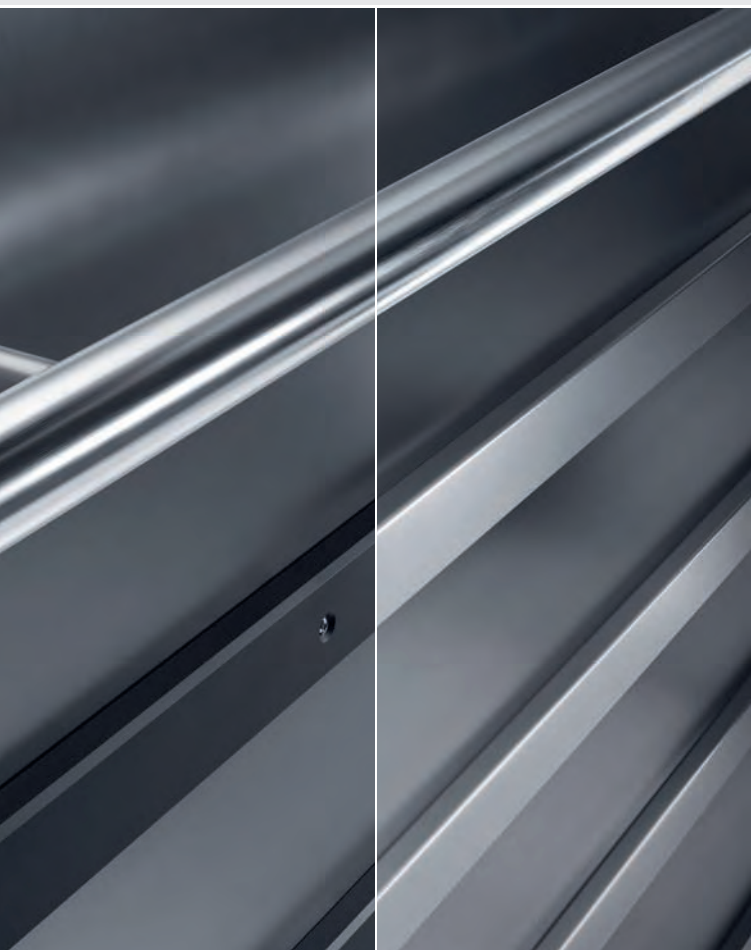
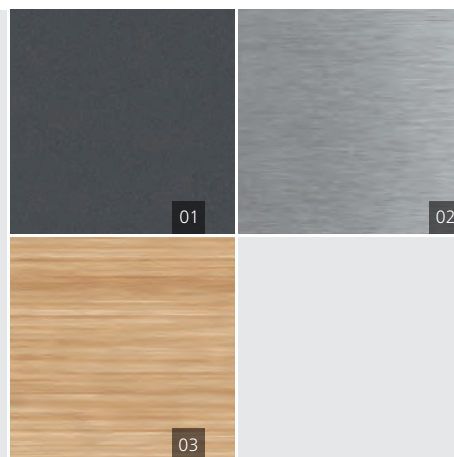

Times Square

Stainless Steel Lucerne Brushed walls
Stainless Steel Lucerne Brushed bumper rails



Your professional and trusted partner

Services to meet your specific needs

We partner with you to find the best mobility solution for your facility. From design through installation, and on through service, our professionals will be there throughout the life cycle of your building.

As your partner, we'll determine what you need and make sure you get it:

- We tailor a mobility solution to your needs. Whether sustainability or energy efficiency is your priority, we can tailor a mobility solution to your needs.
- We offer smart solutions for your equipment, your passengers and you. Experienced, personalized and always accessible.
- We provide a dense network of service stations and certified technicians in over 1000 branches worldwide.

For more information, please contact us:

Schindler Management Ltd.
13 Zugerstrasse, 6030 Ebikon, Switzerland
www.schindler.com

This publication is for general informational purposes only and we reserve the right at any time to alter the services, product design and specifications. No statement contained in this publication shall be construed as a warranty or condition, expressed or implied, as to any service or product, its specifications, its fitness for any particular purpose, merchantability, quality or shall be interpreted as a term or condition of any service or purchase agreement for the products or services contained in this publication. Minor differences between printed and actual colors may exist.



Schindler

We Elevate